

# POWER SUPPLY

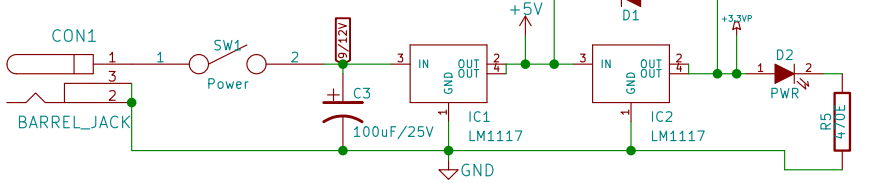

# Wifi ESP01

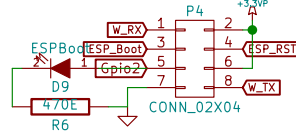

# Bluetooth

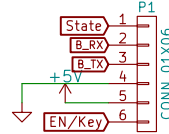

# Ultrasonic

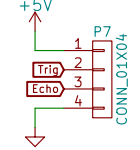

# ADXL335

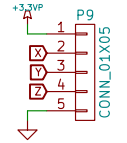

# ADC

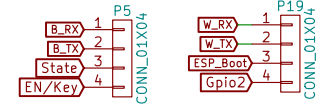
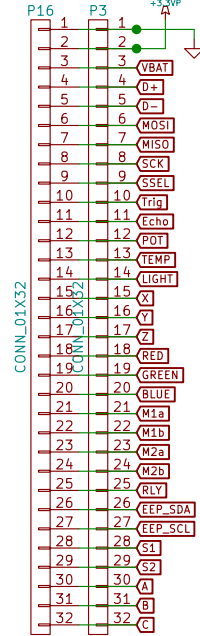
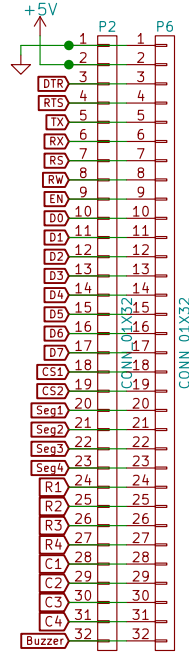
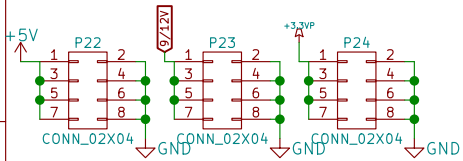
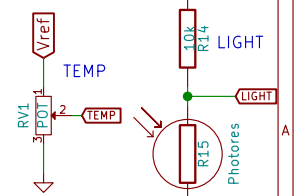

# User\_Switches

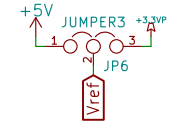
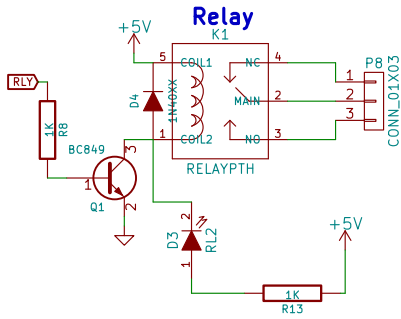
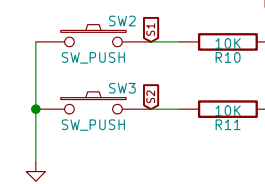

# Buzzer

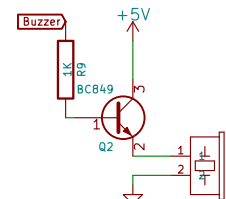

# L293D Driver

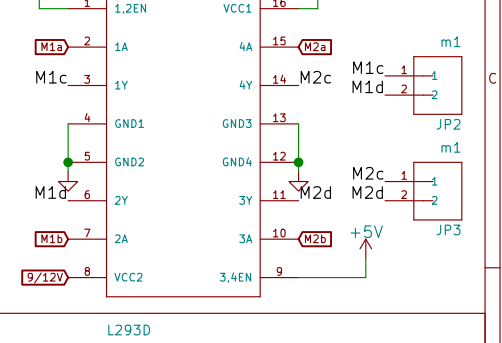

# USB Connector

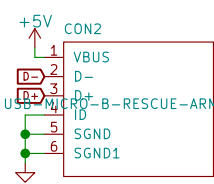

# USB to Serial

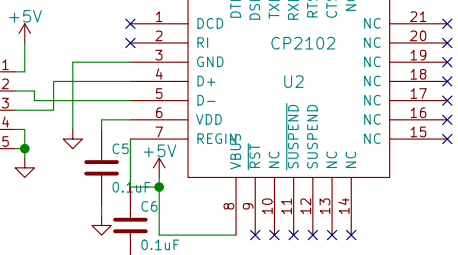

# ESP\_Switches

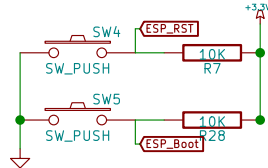

www.exploreembedded.com

Explore Embedded

Sheet: /  
File: One Base Board.sch

**Title: ARM base board**

Size: A4 Date: 17 mar 2016

KiCad E.D.A. kicad 4.0.7

Rev: Ver1.0

Id: 1/3